

PARCELA B

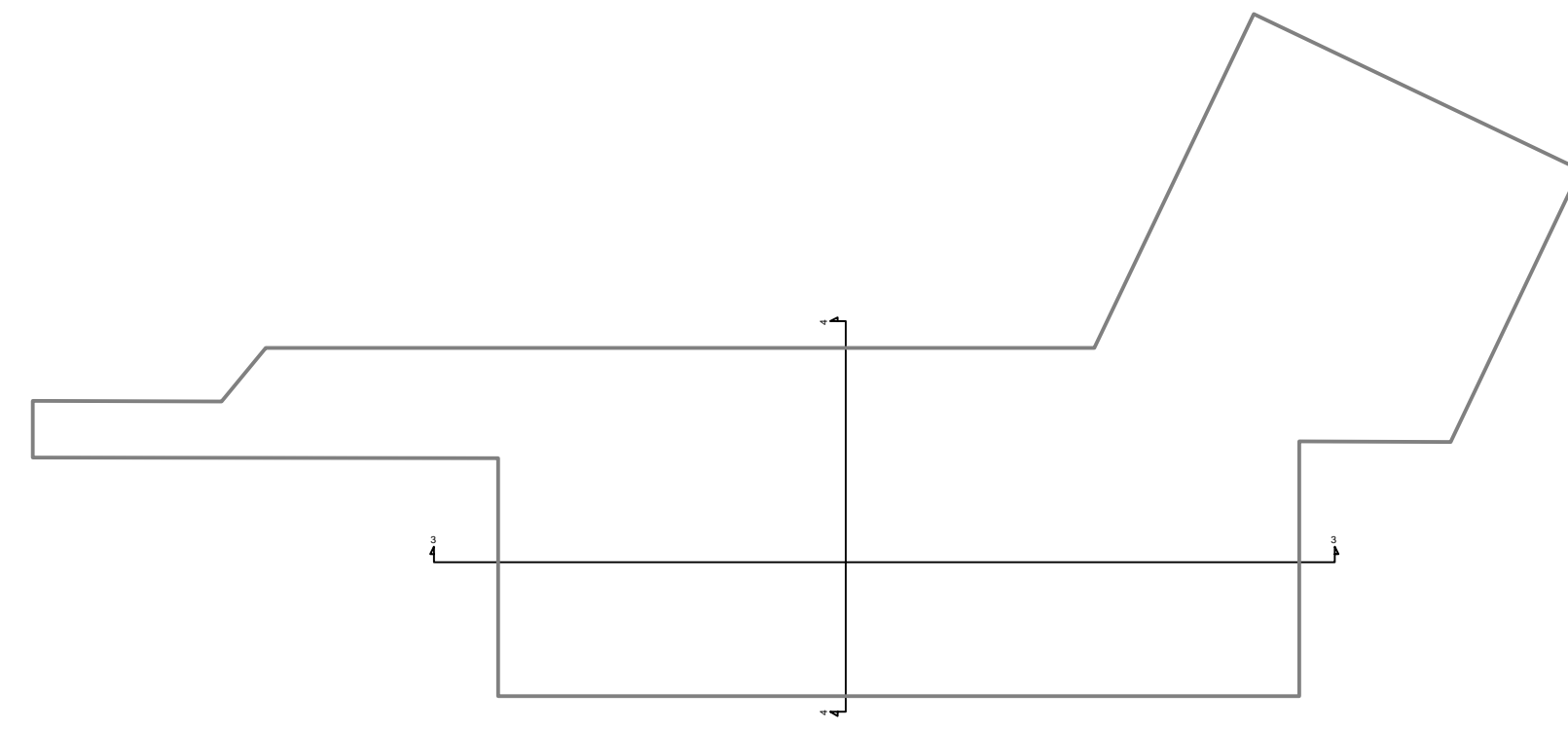

PARCELA E

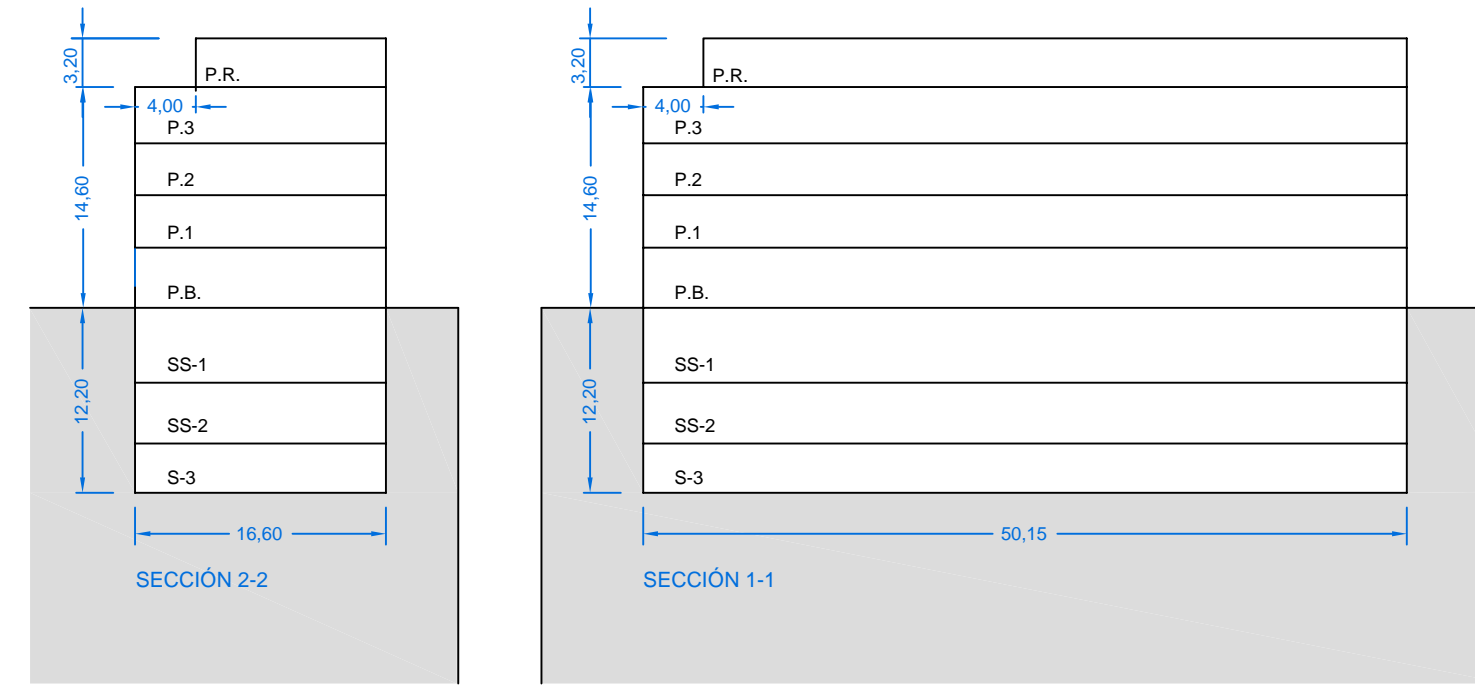
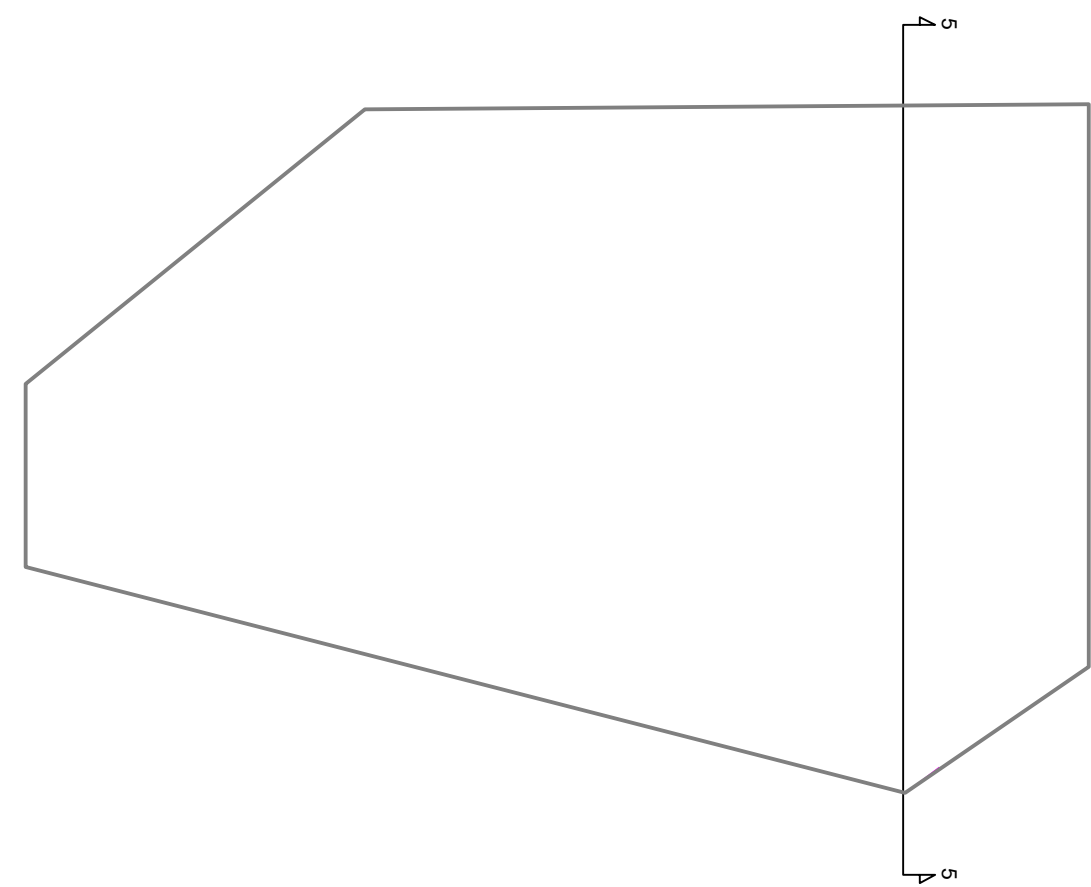
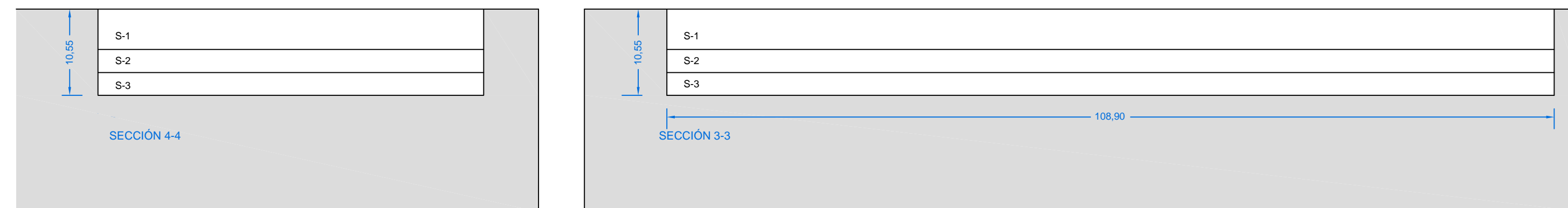

PARCELA C

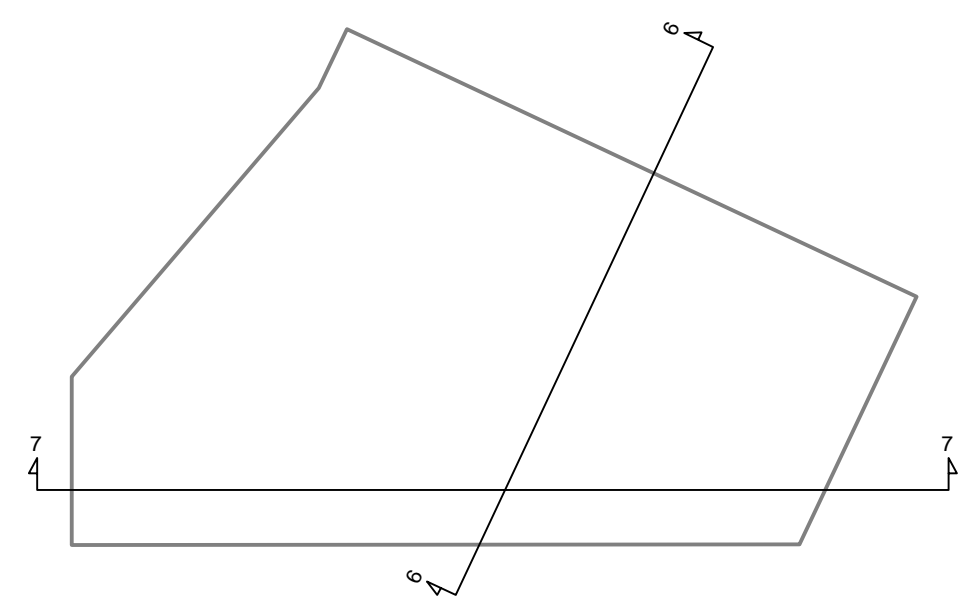
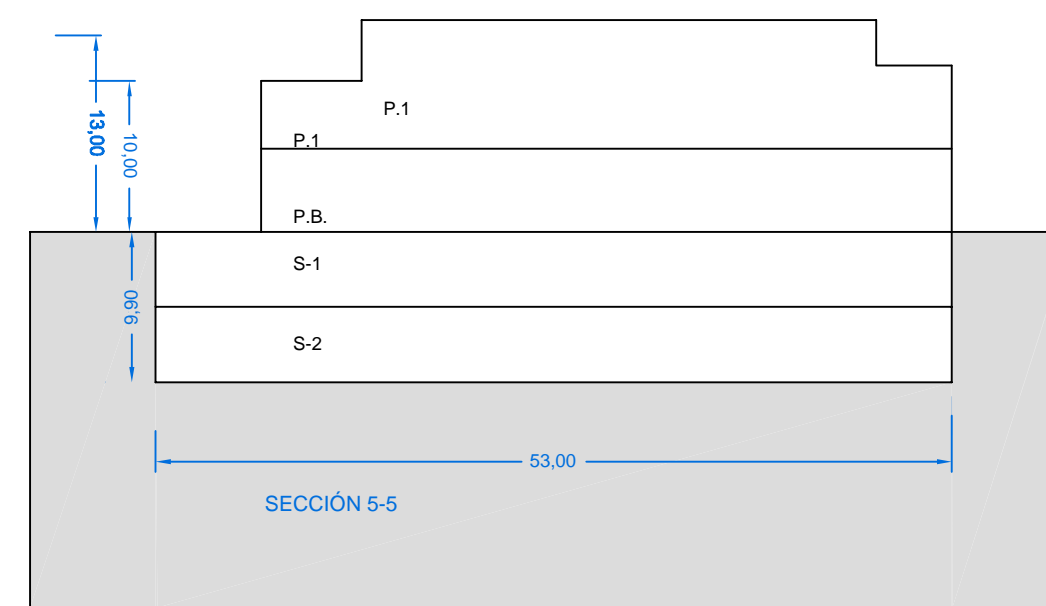

PARCELA D

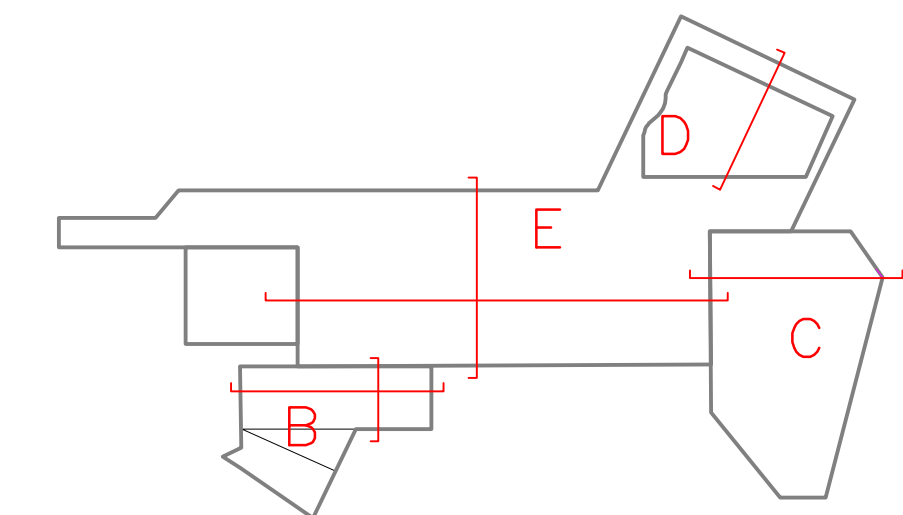
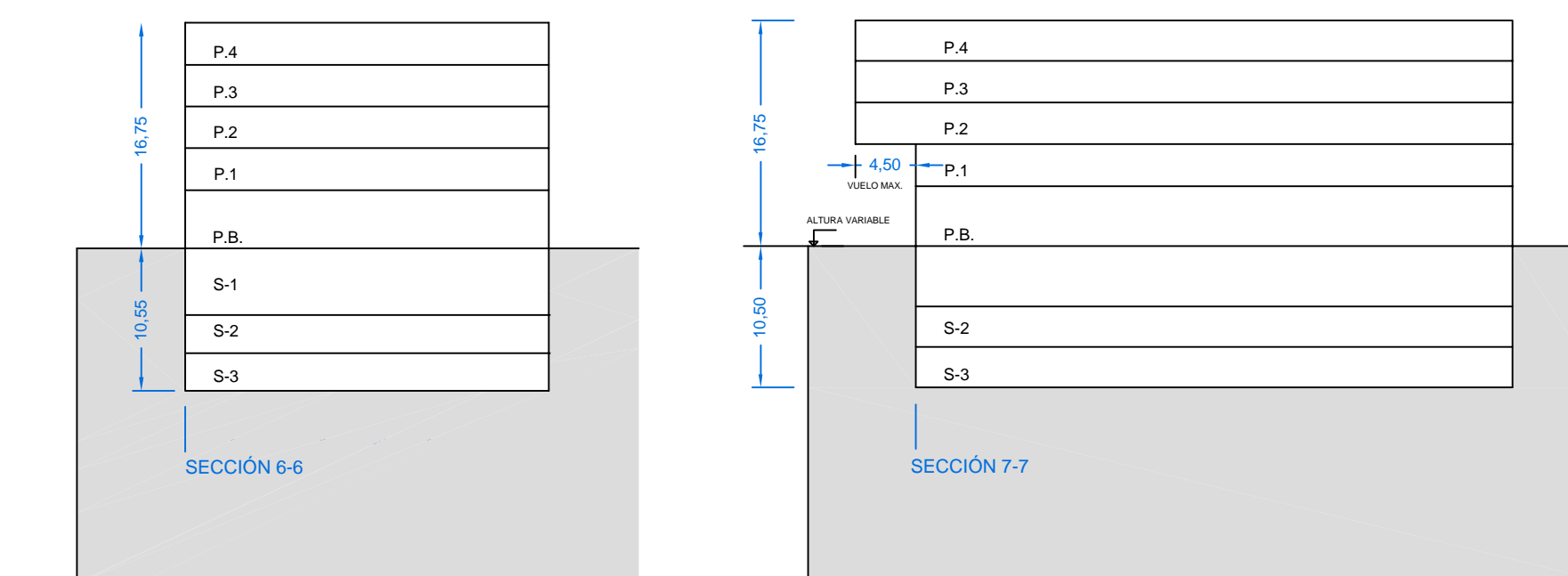

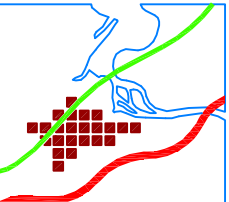
<b>EBAKETAK</b>		<b>P11</b>
<b>SECCIONES</b>		
MODIFICACION DEL PLAN GENERAL DE IRUN: AMBITOS 5.3.11: SAN JUAN-ETXEANDIA Y 5.3.16: SAN MARCIAL-PLAZA SAN JUAN		
	<b>MODIFICACION Nº18</b> UZCANGA ARQUITECTOS S.L. LUIS UZCANGA, ALMUDENA FRANCO	
2007KO APIRILIA / ABRIL DE 2007		